

Varenummer: 2032100M1280A1S
 Beskrivelse: E+G Justerfod
 GN 32-100-M12-80-A1-S
 Note: S Uden møtrik, udvendig sekskant i bunden

Mål

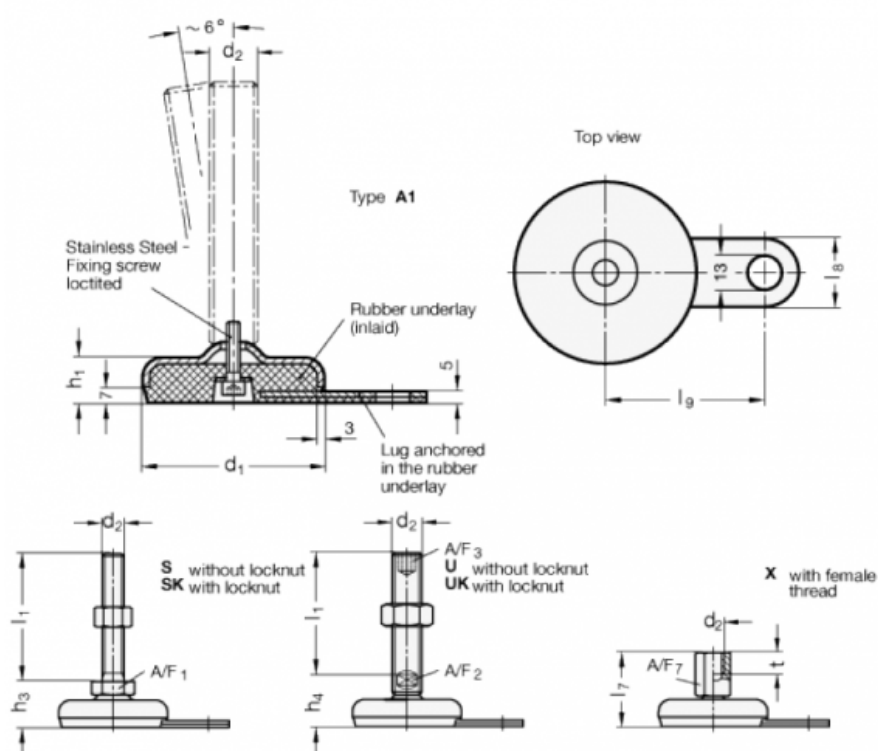

A/F1	= 17
d1	= 100
d2	= M12
h1	= 21
h3	= 29
l1	= 80
l8	= 30
l9	= 80